

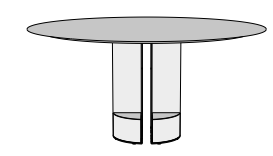





NEWS  
2025



T13  
pg. 04

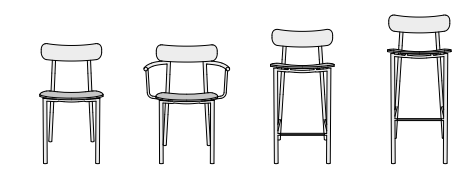

ECH10  
pg. 18

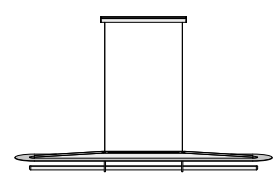

REFLEXO  
pg. 30

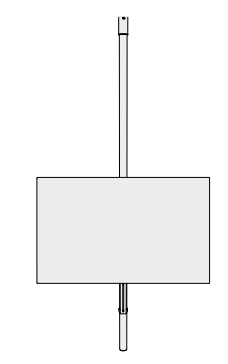

POLE360  
pg. 38

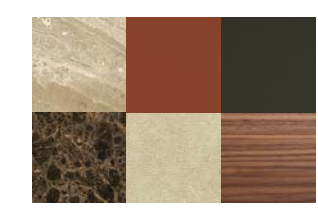

Materials and finishes  
pg. 46

# T13

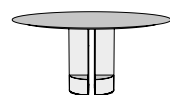

T13 si caratterizza per le contenute dimensioni della base centrale con contrappesi a vista. Tale sistema costruttivo rende il tavolo molto fruibile e stabile anche con le dimensioni dei top più grandi. Un tavolo estremamente personalizzabile in cui si possono scegliere indistintamente le finiture di top, base in acciaio e dei settori di zavorra.

T13 is characterized by the compact size of the central base with visible counterweights. This construction system makes the table very usable and stable even with larger tops. An extremely customizable table, you can choose the finishes of the top, steel base, and ballast sectors independently.

Le T13 se caractérise par les dimensions réduites de la base centrale avec des contrepoids visibles. Ce système de construction rend la table très utilisable et stable même avec des plateaux plus grands. Une table extrêmement personnalisable, vous pouvez choisir indépendamment les finitions du plateau, de la base en acier et des secteurs de lest.

Der T13 zeichnet sich durch die kompakte Größe der zentralen Basis mit sichtbaren Gegengewichten aus. Dieses Konstruktionssystem macht den Tisch sehr benutzerfreundlich und stabil, auch bei größeren Tischplatten. Ein extrem anpassbarer Tisch, bei dem die Oberflächen von Platte, Stahlbasis und Ballastsektoren unabhängig voneinander gewählt werden können.

El T13 se caracteriza por el tamaño contenido de la base central con contrapesos visibles. Este sistema de construcción hace que la mesa sea muy utilizable y estable incluso con tapas más grandes. Una mesa extremadamente personalizable, se pueden elegir indistintamente los acabados de la tapa, la base de acero y los sectores de lastre.



Configura il tuo tavolo  
Configure your table  
[extendoweb.com/configuratore](https://www.extendoweb.com/configuratore)



Disponibili riduzioni a misura  
Custom reductions available  
Réductions sur mesure disponibles  
Verkürzungen auf Maß erhältlich  
Disponibles reducciones a medida



Piedini regolabili in acciaio inox.  
Adjustable feet in stainless steel.  
Pieds réglables en acier inox.  
Regulierbaren Edelstahlfüßchen.  
Patas regulables de acero inoxidable.

## Finiture/Finishes

verificare a listino geometrie e finiture  
check geometries and finishes in the price list

### top tavolo / table top

legno massiccio solid wood	T01 rovere oak	T02 noce walnut	T03 iroko iroko	T05 rovere nero black oak						
HPL	L03 FENIX® bianco white	L06 FENIX® nero black	L08 FENIX® grigio Londra London grey	L13 FENIX® aragona aragona	L14 Kär lino linen	L15 FENIX® rosso Namib Namib red				
HPL + legno HPL + wood	Y36 rovere oak	Y34 noce walnut	Y37 rovere affumicato smoked oak	Y40 frassino argilla clay ash	Y39 frassino nero black ash					
HPL + ecotouch	N01 sabbia sand	N02 basalto basalt	S06 nero black	S07 porfido porfido	S08 cardoso cardoso	S09 Pompei Pompei	S10 Matera Matera	S11 tortora dove grey		
ceramica ceramic	S12 grigio grey	S13 bianco white	S14 terracotta earthenware	S15 muschio moss	Z01 bianco Carrara white Carrara	Z02 nero Marquiña black Marquiña	Z03 verde Alpi Alpi green	Z04 rosso Lepanto red Lepanto	Z05 grigio Carnico grey Carnico	Z06 emperador dark dark emperador
pietra naturale natural stone	Z07 grafite graphite	Z08 travertino sardo travertino sardo	Z09 emperador light light emperador							

### telaio / structure

acciaio verniciato painted steel	C12 bianco white	C42 perla pearl	C21 seta silk	C23 corda ecru	C30 ghisa cast-iron	C14 antracite anthracite
	C08 nero black	C40 mattoni brick	C41 muschio moss	C26 corten corten	C29 bronzo bronze	C37 rame copper

contrappesi disponibili in pietra naturale (Z) o cemento colorato in massa (K01-K02-K03-K04-K05-K06-K07)  
counterweights available in natural stone (Z) or mass-coloured concrete (K01-K02-K03-K04-K05-K06-K07)



pietra naturale  
natural stone



cemento  
concrete

## Dimensioni/Dimensions

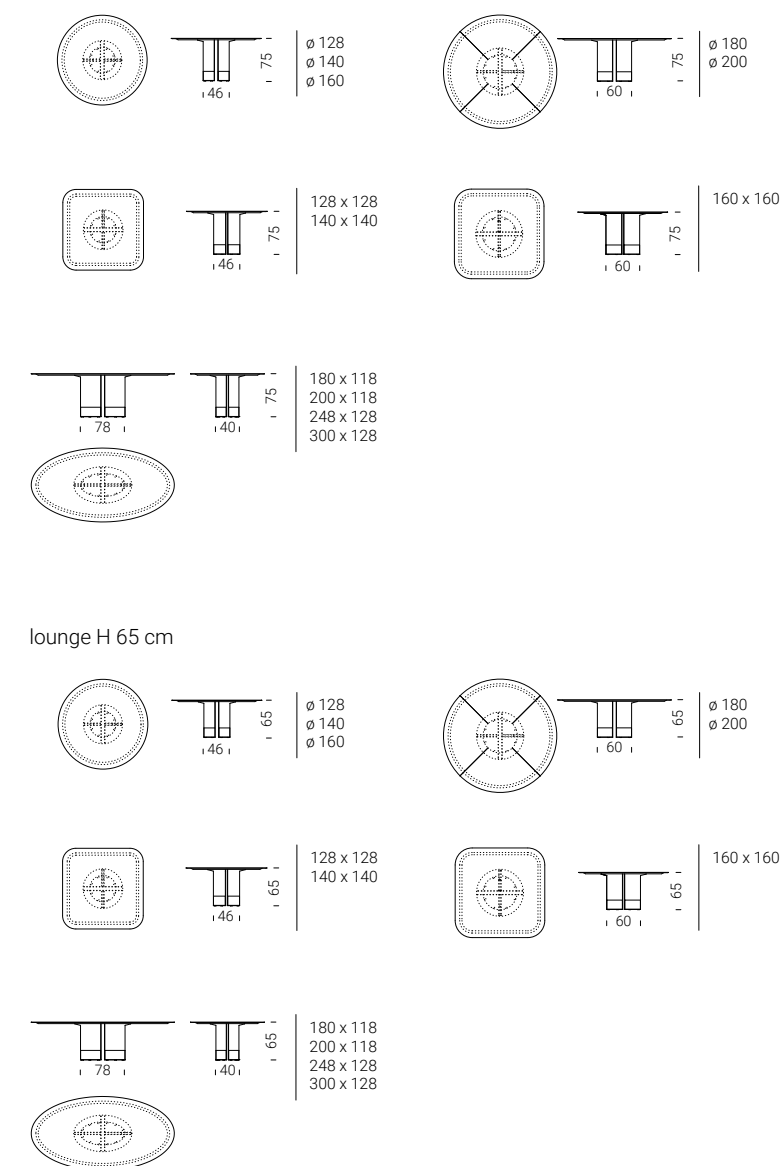

T13  
config. 01

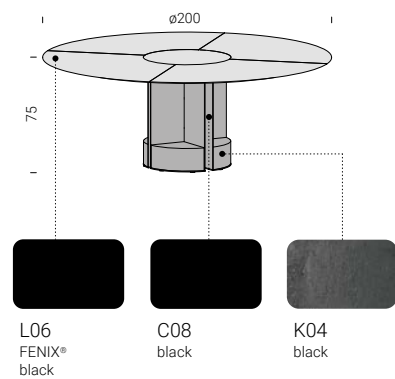

VIKING



CONTRAPPESO

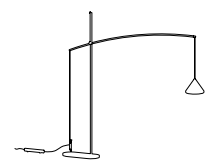

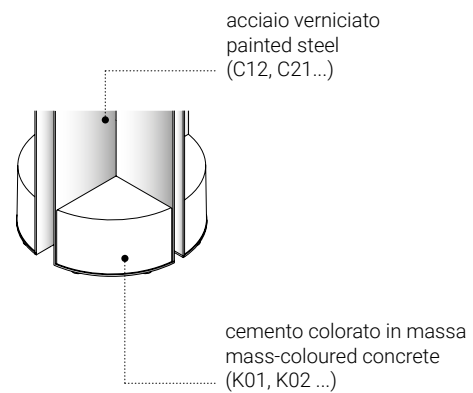

Esempio di abbinamento con telaio in acciaio verniciato e contrappeso in cemento colorato in massa

Example of combination with painted steel frame and mass-coloured concrete counterweight



I pigmenti utilizzati per la colorazione in massa del cemento (K01,K02...) fanno riferimento alle rispettive colorazioni RAL delle verniciature su metallo (C12,C21...)

The pigments used for the mass colouring of the cement (K01,K02...) refer to the respective RAL colours of the metal paints (C12,C21...)

C12 bianco / white (RAL 9003)	<b>K01</b> bianco / white
C21 seta / silk (RAL 7044)	<b>K02</b> seta / silk
C30 ghisa / cast-iron (RAL 7022)	<b>K03</b> ghisa / cast-iron
C08 nero / black (RAL 9005)	<b>K04</b> nero / black
C40 mattone / brick (RAL 8004)	<b>K05</b> mattone / brick
C41 muschio / moss (RAL 6015)	<b>K06</b> muschio / moss
C37 rame / copper	<b>K07</b> rame / copper

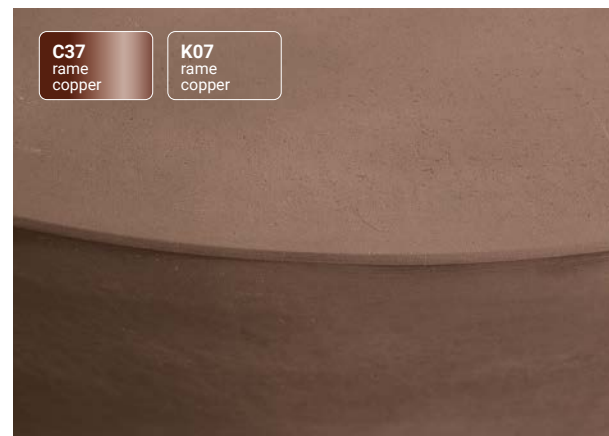
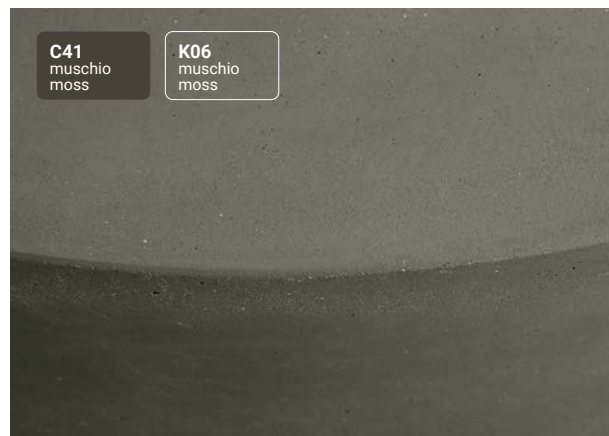
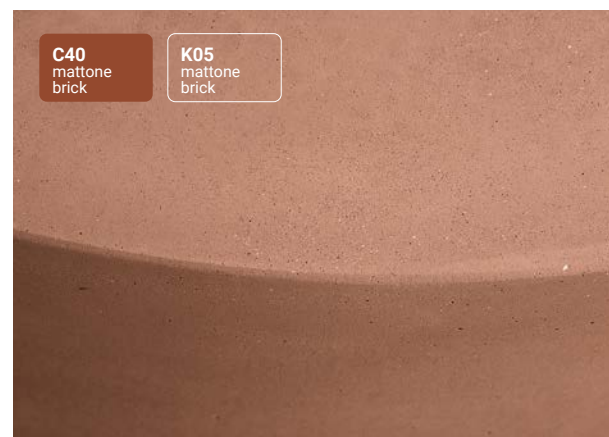
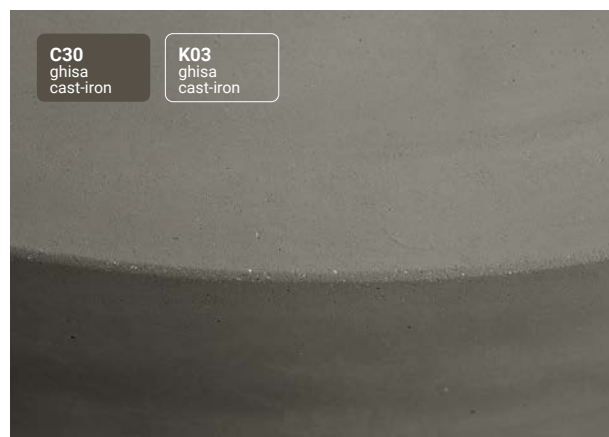

T13  
config. 02

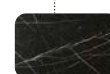
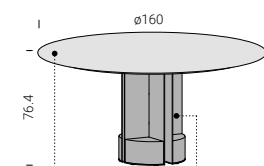

Z02  
black Marquina



C08  
black

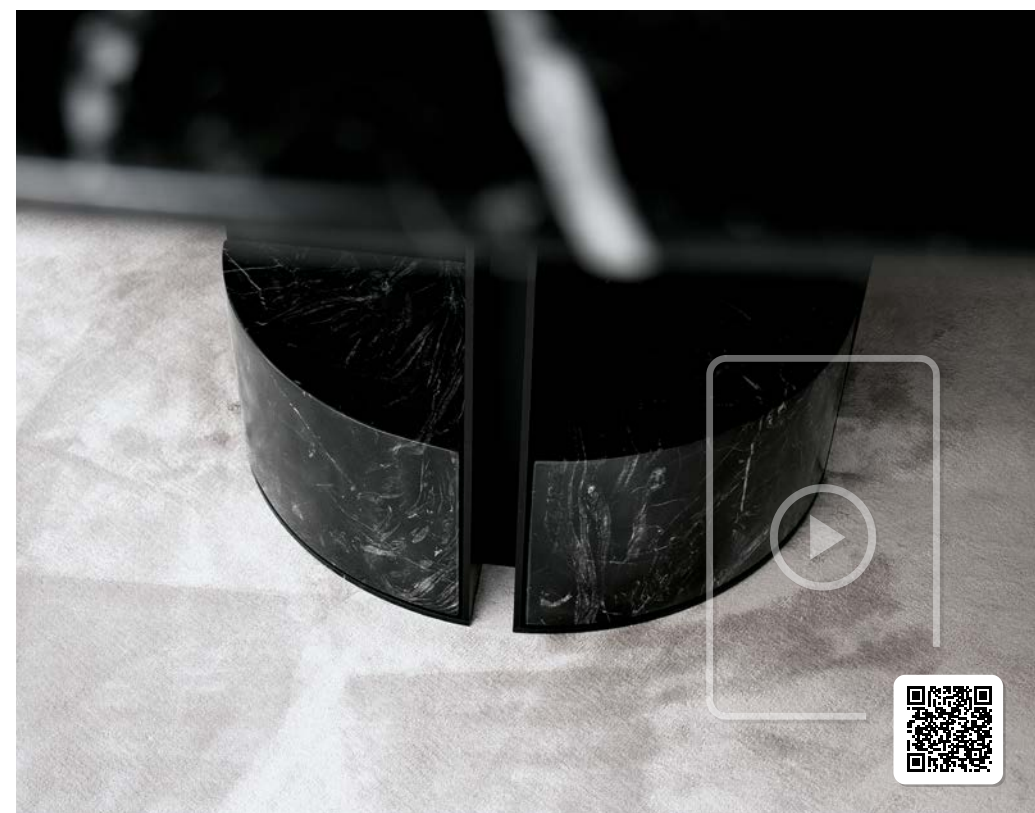

ECH10



T13  
config. 03

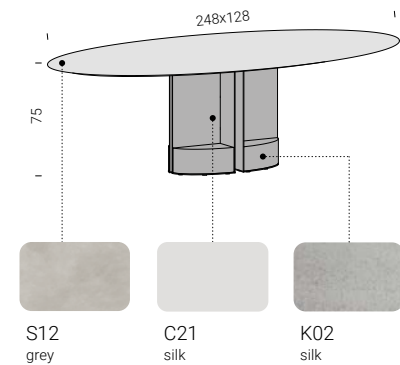

ECH3  





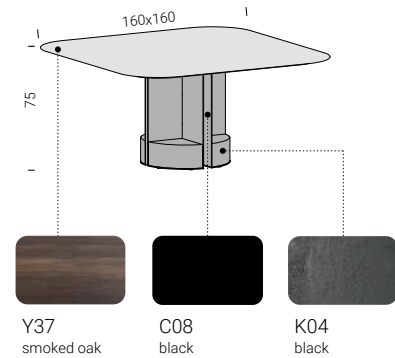

T13  
config. 04



ECH10

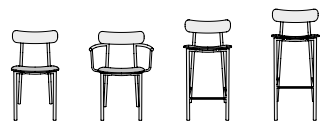

# ECH10



Un design semplice che si ispira ad una delle sedute più classiche, senza tempo, la thonet. In ECH10 è presente il sistema brevettato "schienale adattivo", la versione imbottita è anche ordinabile completamente sfoderabile come sulla maggioranza delle nostre collezioni di sedute.

A simple design inspired by one of the most classic, timeless seats, the Thonet. ECH10 features the patented "adaptive backrest" system, and the upholstered version is also available with completely removable covers, as with the majority of our seating collections.

Un design simple inspiré par l'une des chaises les plus classiques et intemporelles, la Thonet. Le modèle ECH10 est doté du système breveté "dossier adaptatif", et la version rembourrée est également disponible avec des housses entièrement amovibles, comme pour la majorité de nos collections de sièges.

Ein einfaches Design, inspiriert von einem der klassischsten, zeitlosesten Sitzmöbel, dem Thonet. Der ECH10 verfügt über das patentierte "adaptive Rückenlehne"-System, und die gepolsterte Version ist auch mit vollständig abnehmbaren Bezügen erhältlich, wie bei den meisten unserer Sitzkollektionen.

Un diseño sencillo inspirado en uno de los asientos más clásicos y atemporales, el Thonet. El ECH10 cuenta con el sistema patentado de "respaldo adaptativo", y la versión tapizada también está disponible con fundas completamente desmontables, como en la mayoría de nuestras colecciones de asientos.



Configura la tua sedia  
Configure your chair  
[extendoweb.com/configuratore](https://extendoweb.com/configuratore)



Schienale adattivo  
Adjustable backrest  
Dossier adaptatif  
Adaptive Rückenlehne  
Respaldo adaptable



ADAPTIVE  
CHAIR BACKREST  
registered community  
design



Sfoderabile  
Removable upholstery  
Déhoussable  
Abnehmbares Polsterzeug  
Cubierta desmontable



Piedini intercambiabili  
Interchangeable feet  
Pieds interchangeables  
Austauschbare Füße  
Pies intercambiables

## Finiture/Finishes

fondello e schienale / seat and back

	essenze woods	Y36 rovere oak	Y34 noce walnut	Y37 rovere affumicato smoked oak	Y40 frassino argilla clay ash	Y39 frassino nero black ash	
	pelle leather	F21 ossido oxide	F22 caffè coffee	F23 inchiostro ink			
	100% poliestere/polyester peso/weight 400 gr/mq BSI: 50.000 cicli/cycles	JA01 perla pearl	JA02 avorio ivory	JA03 fango mud	JA04 salvia sage	JA05 oliva olive	JA06 cipria powder pink
	50% cotone/cotton 40% poliestere/polyester 10% poliacrilico/polyacrylic peso/weight 430 gr/mq BSI: 40.000 cicli/cycles	JB01 natur natur	JB02 ecru ecru	JB03 grigio grey	JB04 cenere ash	JB05 platino platinum	JB06 antracite anthracite
	60% lino/linen 40% viscosa/viscose peso/weight 550 gr/mq BSI: 20.000 cicli/cycles	JC01 fumo smoke	JC02 cenere ash	JC03 sacco sack	JC04 terra land	JC05 verde green	JC06 rosa pink

telaio / structure

	acciaio verniciato painted steel	C12 bianco white	C42 perla pearl	C21 seta silk	C23 corda ecru	C30 ghisa cast-iron	C14 antracite anthracite
		C08 nero black	C40 mattone brick	C41 muschio moss	C26 corten corten	C29 bronzo bronze	C37 rame copper

## Dimensioni/Dimensions

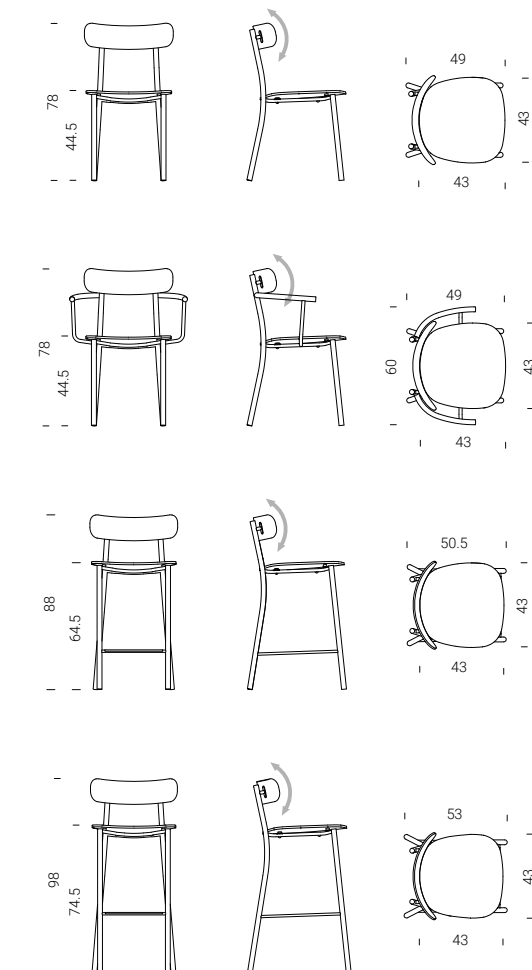

verificare a listino disponibilità, composizione e consigli di lavaggio per i tessuti.  
check availability, composition and washing recommendations for fabrics in the price list.

ECH10  
config. 01

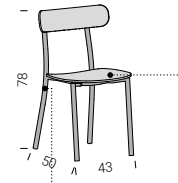

BALANCE

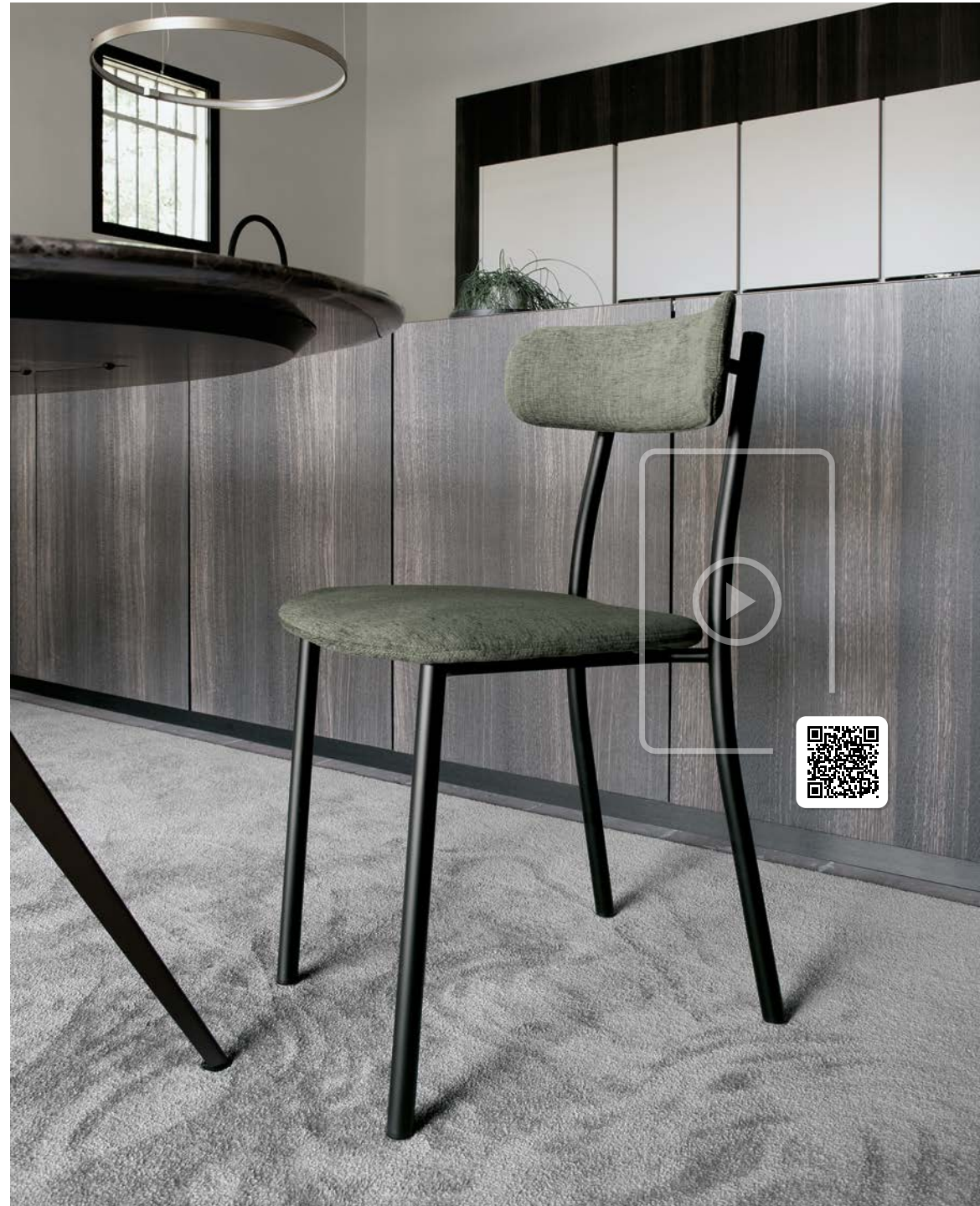

ECH10  
config. 02

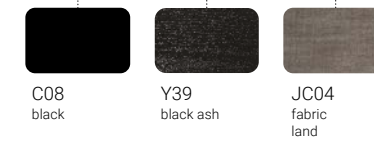
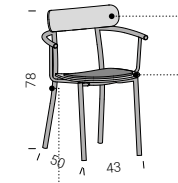

BALANCE

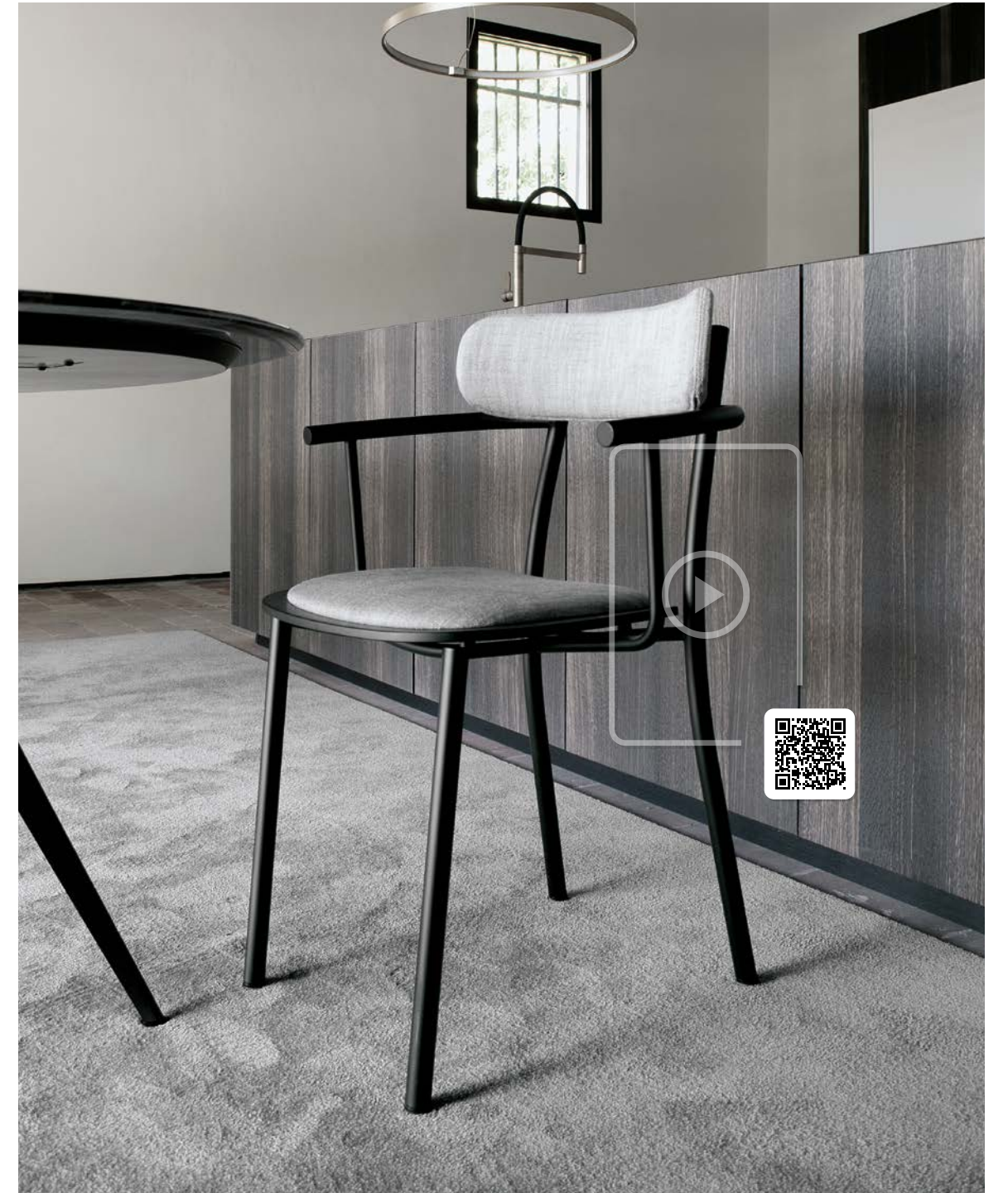

ECH10  
config. 03

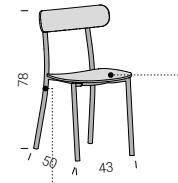

C08  
black



JB05  
fabric  
platinum

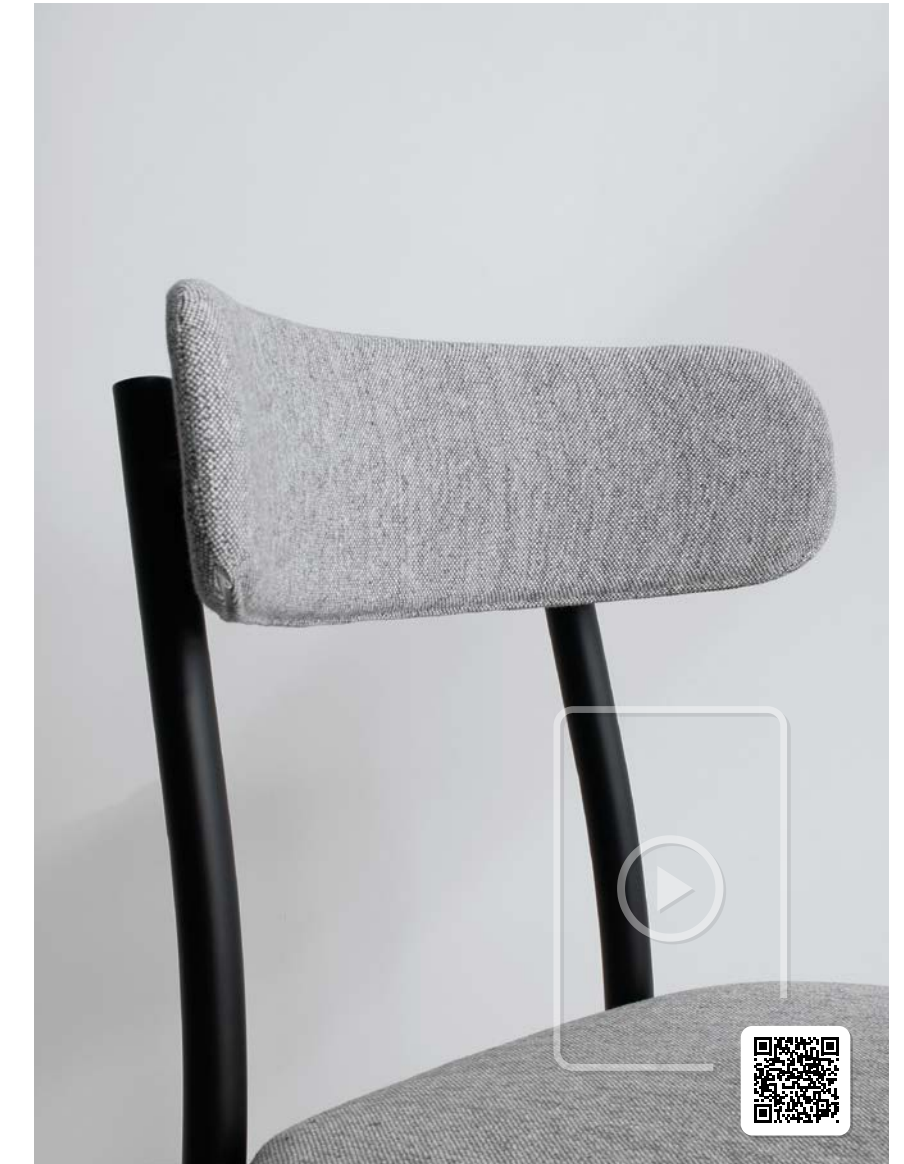

BALANCE



ECH10  
config. 04

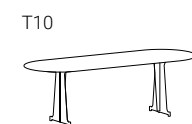
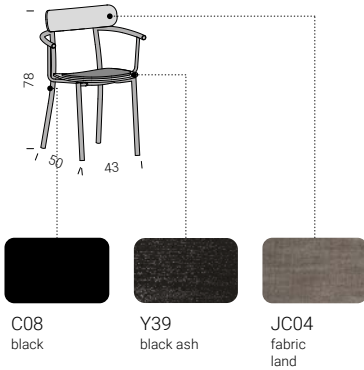

ECH10  
config. 05

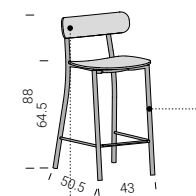

Y39  
black ash



C08  
black







# REFLEXO

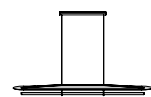

Reflexo è una lampada a luce riflessa/indiretta, una tipologia di illuminazione che evita l'abbagliamento e al contempo distribuisce la luce in modo graduale. Un foglio bianco di soli 3mm di spessore è il diffusore della luce che si espande sul top del tavolo e nell'intorno. E' dotata di fonte luminosa anche nella parte superiore, dimmerabile separatamente.

Reflexo is a lamp with reflected/indirect light, a type of lighting that avoids glare while gradually distributing light. A white sheet only 3mm thick serves as the diffuser, spreading light over the tabletop and the surrounding area. It is also equipped with a light source in the upper part, which can be dimmed separately.

Reflexo est une lampe à lumière réfléchi/indirecte, un type d'éclairage qui évite l'éblouissement tout en distribuant la lumière de manière graduelle. Une feuille blanche de seulement 3 mm d'épaisseur sert de diffuseur, répandant la lumière sur le dessus de la table et autour. Elle est également équipée d'une source lumineuse dans la partie supérieure, réglable séparément.

Reflexo ist eine Lampe mit reflektiertem/indirektem Licht, eine Art der Beleuchtung, die Blendung vermeidet und gleichzeitig das Licht allmählich verteilt. Ein weißes Blatt von nur 3 mm Dicke dient als Diffusor und verbreitet das Licht über die Tischplatte und die Umgebung. Sie ist auch mit einer separaten dimmbaren Lichtquelle im oberen Teil ausgestattet.

Reflexo es una lámpara con luz reflejada/indirecta, un tipo de iluminación que evita el deslumbramiento mientras distribuye la luz de manera gradual. Una hoja blanca de solo 3 mm de grosor sirve como difusor, expandiendo la luz sobre la superficie de la mesa y el entorno. También está equipada con una fuente de luz en la parte superior, regulable por separado.

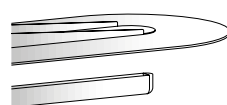

Strip Led SMD  
LED/mt. 192  
Lumen: 4690 lm/mt.  
Power 34 W/mt.  
Tension 24 V  
Color Temperature: 2700°K or 3000°K  
Dimming range 1-100%  
CRI > 90

## Finiture/Finishes

struttura / structure

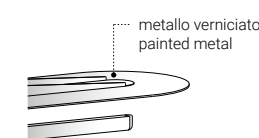

## Dimensioni/Dimensions

verificare a listino geometrie e finiture  
check geometries and finishes in the price list

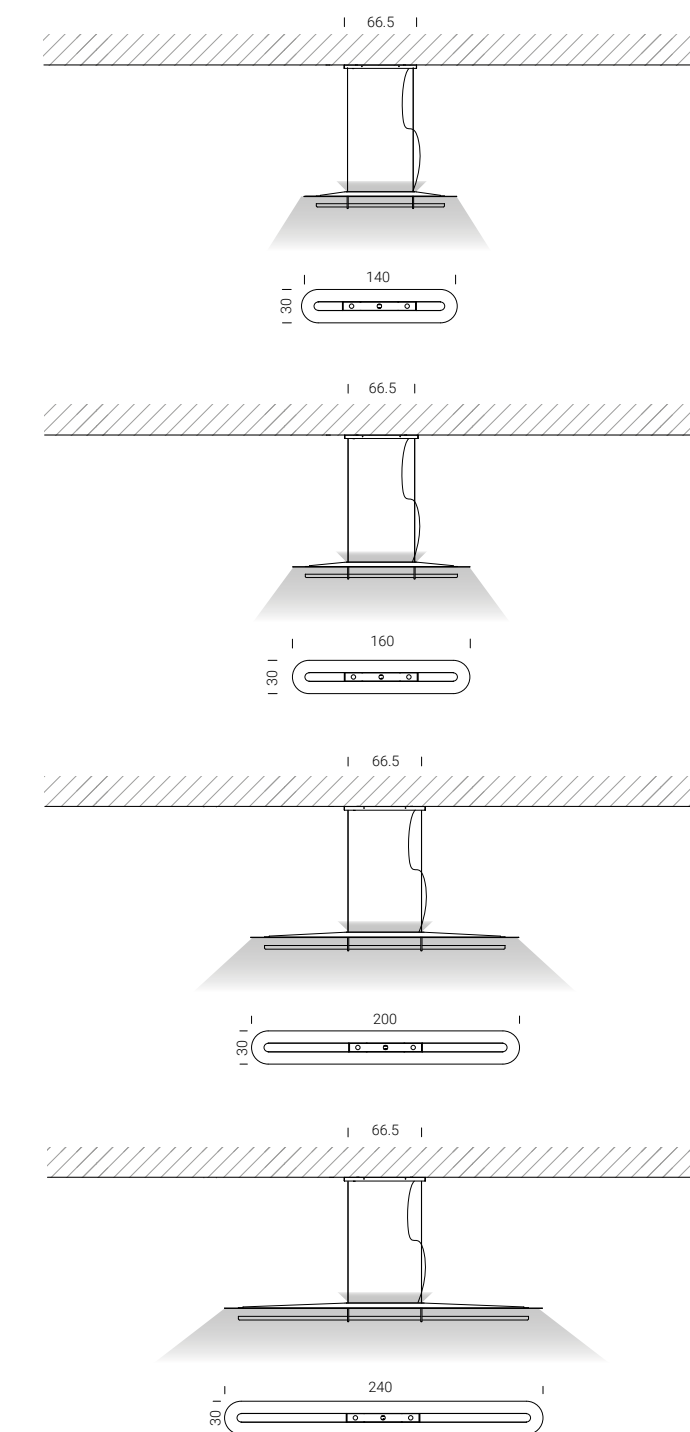

REFLEXO  
config. 01

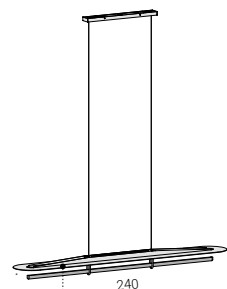

C08  
black

ECH9



EWS

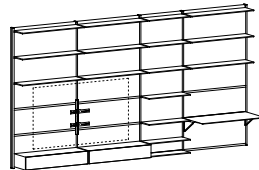

BALANCE

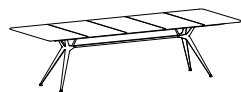

REFLEJO  
config. 02

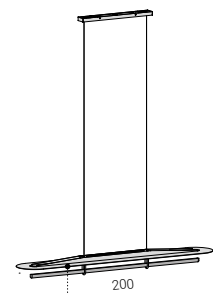

C08  
black

VIKING



SPILLO

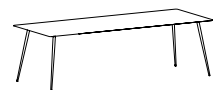

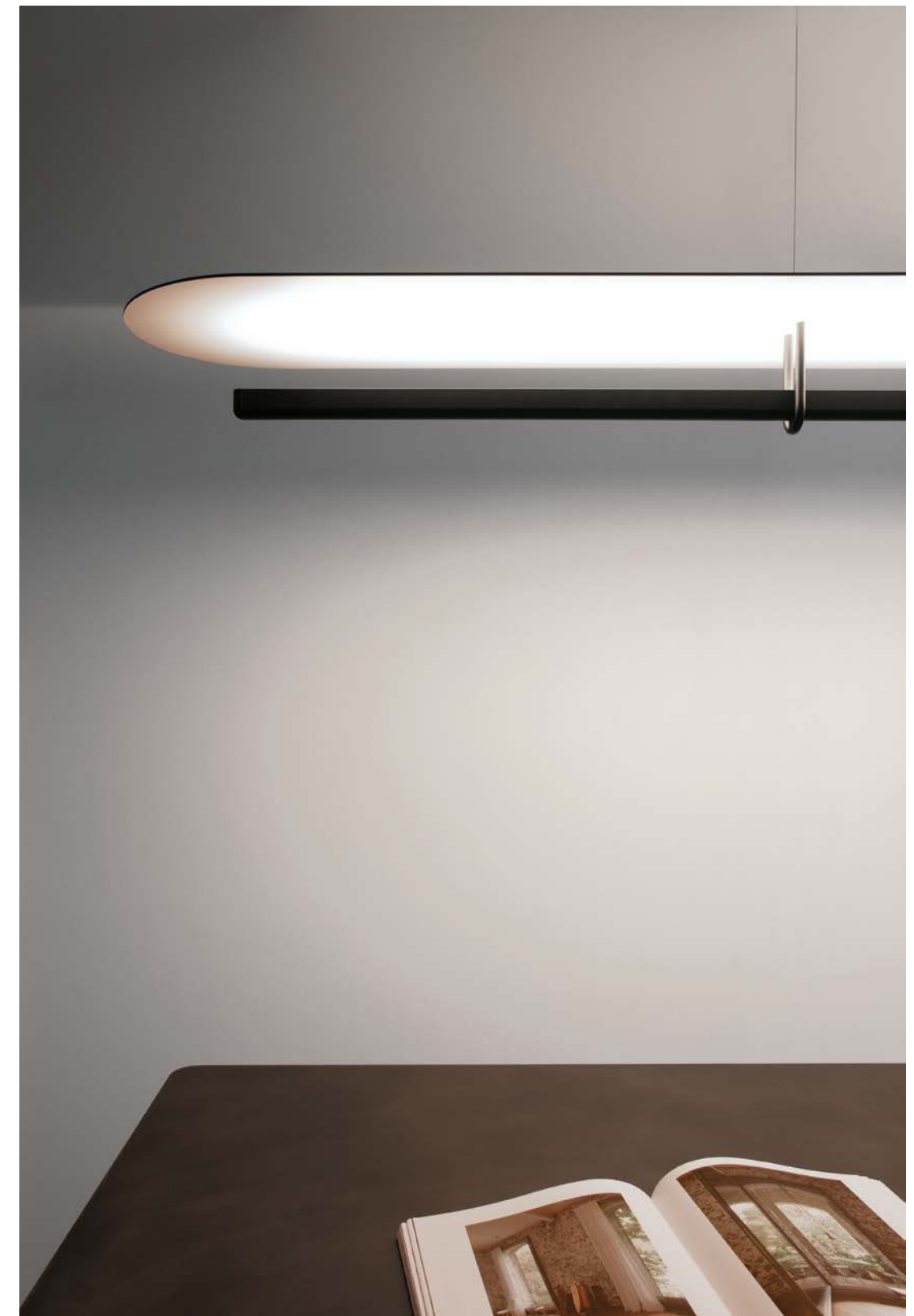

# POLE360

TV dimension 55 - 85"

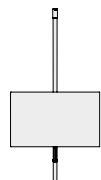

Dalla nostra decennale esperienza nella progettazione di sistemi per unità multimediali, abbiamo voluto riassumere il meglio delle caratteristiche di versatilità e design in Pole360. Il sistema consente una libera installazione delle TV con possibilità di rotazione a 360°, i cavi sono nascosti all'interno del supporto e possono avere accesso dalla parte inferiore o superiore.

Drawing on our decades of experience in designing systems for multimedia units, we have encapsulated the best features of flexibility and design in Pole360. The system allows for free installation of TVs with 360° rotation capability, the cables are hidden inside the support and can be accessed from either the bottom or the top.

Fort de notre expérience de plusieurs décennies dans la conception de systèmes pour unités multimédias, nous avons résumé le meilleur des caractéristiques de flexibilité et de design dans Pole360. Le système permet une installation libre des téléviseurs avec une rotation à 360°, les câbles sont cachés à l'intérieur du support et peuvent être accessibles par le bas ou par le haut.

Basierend auf unserer jahrzehntelangen Erfahrung in der Gestaltung von Systemen für Multimedia-Einheiten haben wir die besten Eigenschaften von Flexibilität und Design im Pole360 zusammengefasst. Das System ermöglicht eine freie Installation von Fernsehern mit 360°-Drehung, die Kabel sind im Inneren der Halterung verborgen und können von unten oder oben zugänglich sein.



Con nuestra experiencia de décadas en el diseño de sistemas para unidades multimedia, hemos resumido las mejores características de flexibilidad y diseño en Pole360. El sistema permite una instalación libre de televisores con capacidad de rotación de 360°, los cables están ocultos dentro del soporte y se puede acceder a ellos desde la parte inferior o superior.



i cavi della TV e di eventuali unità multimediali sono completamente nascosti.  
the TV and multimedia unit wires are completely hidden.

les fils de la TV et des unités multimédias sont complètement dissimulés.

Die Kabel des Fernsehers und der Multimedia sind vollkommen unsichtbar.

los cables de la TV y de los sistemas multimedia quedan completamente ocultos.



supporto monitor universale per TV da 55 a 85 pollici.  
universal monitor support for TV from 55 to 85 inches.

support moniteur universel pour TV de 55 à 85 pouces.

Universal-Monitor-Halter für TV von 55 bis 85 Zoll.

soporte de monitor universal para TV de 55 a 85 pulgadas.



Rotazione 360°  
Rotation 360°  
Rotation 360°  
Rotación 360°

## Finiture/Finishes

verificare a listino dimensioni e finiture  
check dimensions and finishes in the price list

telaio / structure

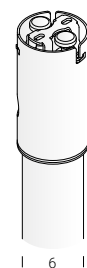

acciaio verniciato  
painted steel



C12  
bianco  
white



C21  
seta  
silk



C23  
corda  
ecrú



C30  
ghisa  
cast-iron



C14  
antracite  
anthracite



C08  
nero  
black



C29  
bronzo  
bronze

accessori / accessories

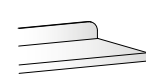

acciaio verniciato  
painted steel

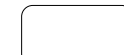

C12  
bianco  
white



C21  
seta  
silk



C23  
corda  
ecrú



C30  
ghisa  
cast-iron



C14  
antracite  
anthracite



C08  
nero  
black



C29  
bronzo  
bronze

## Dimensioni/Dimensions

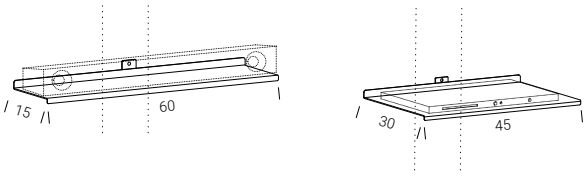
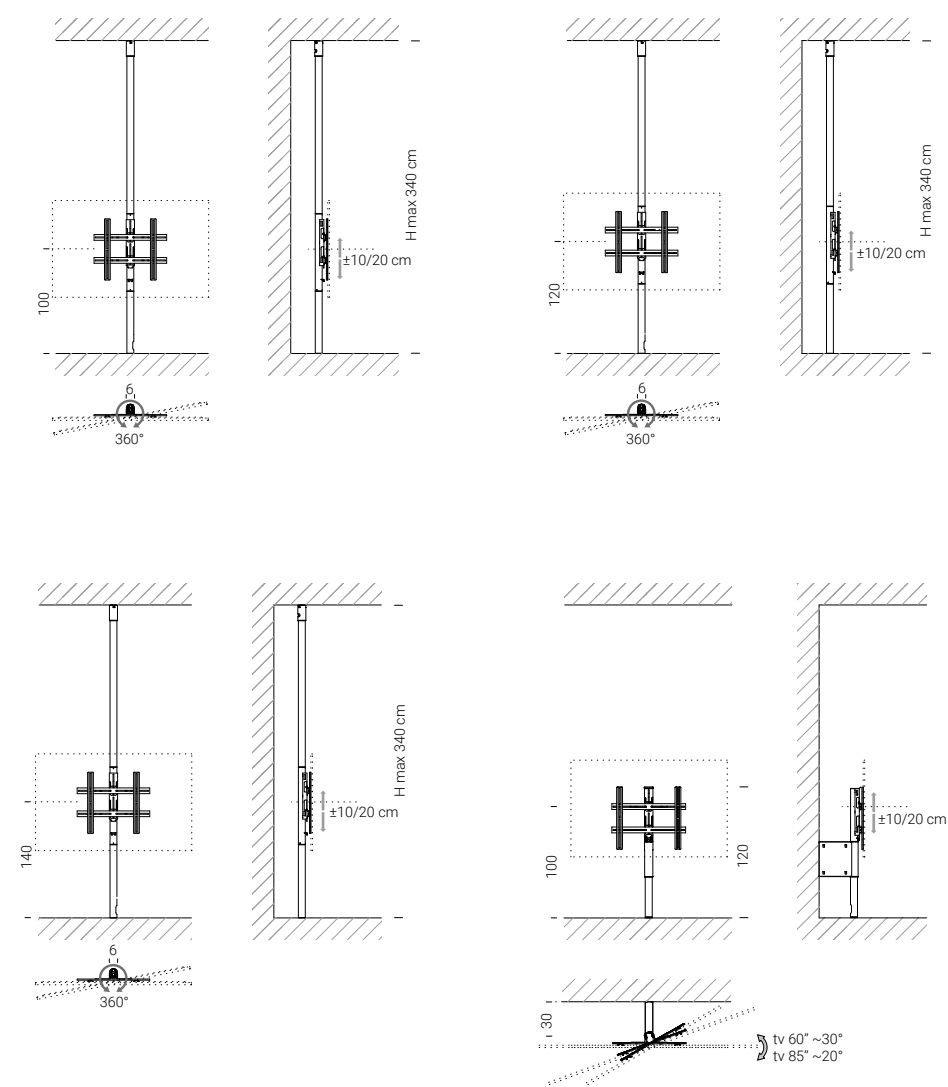

POLE360  
config. 01

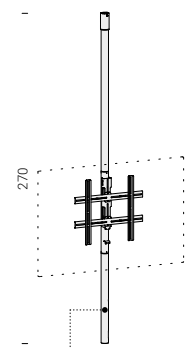

C08  
black



POLE360  
config. 02

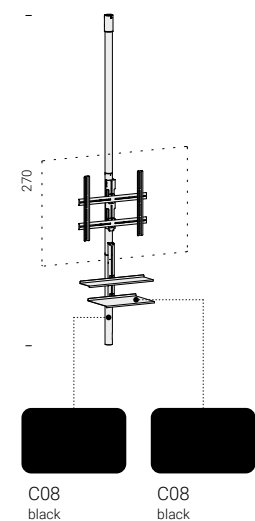

POLE360  
config. 03

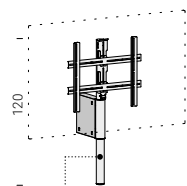

C08  
black





# Materials and finishes

La nuova palette cromatica disponibile nel catalogo news 2025 è il risultato della continua ricerca di nuovi materiali e finiture. Sono presenti 16 famiglie di finiture utilizzabili nelle diverse collezioni, l'attenta scelta delle superfici ha dato priorità alle performance di resistenza e all'esaltazione dell'esperienza cromatica e tattile.

The new color palette available in the 2025 news catalog is the result of continuous research into new materials and finishes. There are 16 families of finishes that can be used in the various collections. The careful selection of surfaces has prioritized performance in terms of resistance and enhancement of the chromatic and tactile experience.

La nouvelle palette de couleurs disponible dans le catalogue des nouveautés 2025 est le résultat d'une recherche continue de nouveaux matériaux et finitions. Il y a 16 familles de finitions pouvant être utilisées dans les différentes collections. Le choix minutieux des surfaces a donné la priorité aux performances de résistance et à l'amélioration de l'expérience chromatique et tactile.

Die neue Farbpalette, die im News-Katalog 2025 verfügbar ist, ist das Ergebnis kontinuierlicher Forschung nach neuen Materialien und Oberflächen. Es gibt 16 Familien von Oberflächen, die in den verschiedenen Kollektionen verwendet werden können. Bei der sorgfältigen Auswahl der Oberflächen wurde die Priorität auf Widerstandsleistung und die Verbesserung des chromatischen und taktilen Erlebnisses gelegt.

La nueva paleta de colores disponible en el catálogo de novedades 2025 es el resultado de la continua investigación de nuevos materiales y acabados. Hay 16 familias de acabados que se pueden utilizar en las diferentes colecciones. La cuidadosa selección de las superficies ha priorizado el rendimiento en términos de resistencia y la mejora de la experiencia cromática y táctil.



## Materiali e finiture / Materials and finishes

⚠ Verifica a listino la disponibilità delle finiture corrispondenti ad ogni collezione/prodotto  
Check the price list for the availability of finishes corresponding to each collection/product.  
Vérifiez dans la liste des prix la disponibilité des finitions correspondant à chaque collection/produit.

⚠ Überprüfen Sie in der Preisliste die Verfügbarkeit der Oberflächen, die den einzelnen Kollektionen/Produkten entsprechen.  
Vérifiez en la lista de precios la disponibilidad de los acabados correspondientes a cada colección/producto.

### Verniciature a polveri / Powder coatings

<b>C12</b> bianco/white RAL 9003	<b>C42</b> perla/pearl RAL 1013 <b>new!</b>	<b>C21</b> seta/silk RAL 7044	<b>C23</b> corda/ecru RAL 7030	<b>C30</b> ghisa/cast-iron RAL 7022	<b>C14</b> antracite/anthracite RAL 7043
<b>C08</b> nero/black RAL 9005	<b>C40</b> mattone/brick RAL 8004 <b>new!</b>	<b>C41</b> muschio/moss RAL 6015 <b>new!</b>	<b>C26</b> corten/corten	<b>C29</b> bronzo/bronze	<b>C37</b> rame/copper

### Laccature / Lacquered

<b>Q05</b> bianco/white RAL 9003	<b>Q16</b> seta/silk RAL 7044	<b>Q17</b> corda/ecru RAL 7030	<b>Q20</b> ghisa/cast-iron RAL 7022	<b>Q14</b> antracite/anthracite RAL 7043	<b>Q04</b> nero/black RAL 9005
<b>Q23</b> mattone/brick RAL 8004 <b>new!</b>	<b>Q24</b> muschio/moss RAL 6015 <b>new!</b>	<b>Q21</b> bronzo/bronze	<b>QCOLOR</b> laccatura a codice RAL-NCS lacquering with RAL-NCS code <b>new!</b>		
<b>X01</b> rame/copper	<b>X02</b> ottone/brass	<b>X03</b> titanio/titanium			

## Materiali e finiture / Materials and finishes

⚠ Verifica a listino la disponibilità delle finiture corrispondenti ad ogni collezione/prodotto  
Check the price list for the availability of finishes corresponding to each collection/product.  
Vérifiez dans la liste des prix la disponibilité des finitions correspondant à chaque collection/produit.

⚠ Überprüfen Sie in der Preisliste die Verfügbarkeit der Oberflächen, die den einzelnen Kollektionen/Produkten entsprechen.  
Verifique en la lista de precios la disponibilidad de los acabados correspondientes a cada colección/producto.

### EsENZE / Woods



Y36 rovere/oak    Y34 noce/walnut    Y37 rovere affumicato/smoked oak    Y38 rovere nero/black oak    Y40 frassino argilla/clay ash

### Vetri trasparente / Transparent glasses



V07 float    V06 fumé/smoked glass

### Tessuti / Fabrics



JA01 perla/pearl    JA02 avorio/ivory    JA03 fango/mud    JA04 salvia/sage    JA05 oliva/olive    JA06 cipria/powder pink

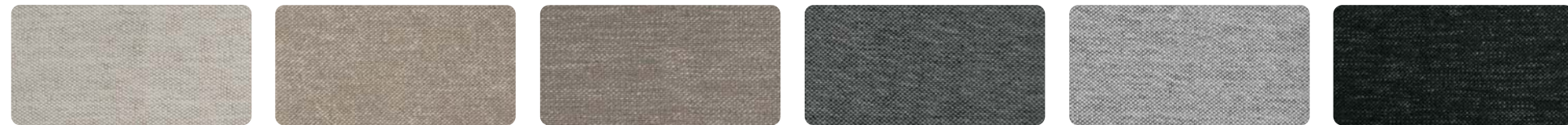

JB01 natur/natur    JB02 ecru/ecru    JB03 grigio/grey    JB04 cenere/ash    JB05 platino/platinum    JB06 antracite/anthracite



JC01 fumo/smoke    JC02 cenere/ash    JC03 sacco/sack    JC04 terra/land    JC05 verde/green    JC06 rosa/pink

## Materiali e finiture / Materials and finishes

⚠ Verifica a listino la disponibilità delle finiture corrispondenti ad ogni collezione/prodotto  
Check the price list for the availability of finishes corresponding to each collection/product.  
Vérifiez dans la liste des prix la disponibilité des finitions correspondant à chaque collection/produit.

⚠ Überprüfen Sie in der Preisliste die Verfügbarkeit der Oberflächen, die den einzelnen Kollektionen/Produkten entsprechen.  
Verifique en la lista de precios la disponibilidad de los acabados correspondientes a cada colección/producto.

### Cuoio / cow-hide

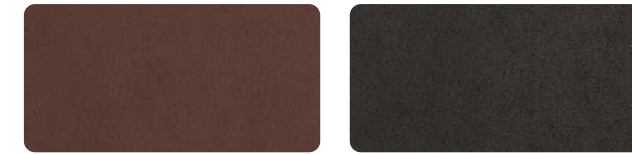

F01 tabacco/tobacco    F02 nero/black

### Pelli naturali / Natural leathers

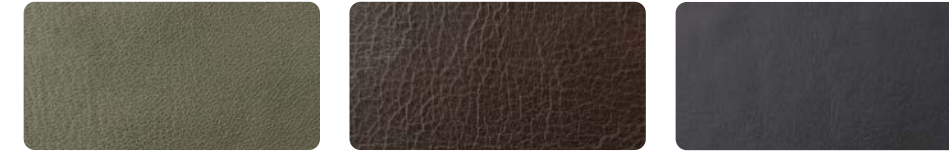

F21 ossido/oxide    F22 caffè/coffee    F23 inchiostro/ink

### Legni massicci / Solid woods



T01 rovere/oak    T02 noce/walnut    T03 iroko/iroko    T04 iroko outdoor/iroko outdoor    T05 rovere nero/black oak

### HPL



L03 FENIX® bianco/white    L06 FENIX® nero/black    L08 FENIX® grigio Londra/London grey    L13 FENIX® aragona/aragona    L14 Kèr lino/linen    L15 FENIX® rosso Namib/Namib red

### HPL+legno / HPL+wood



Y36 rovere/oak    Y34 noce/walnut    Y37 rovere affumicato/smoked oak    Y39 frassino nero/black ash    Y40 frassino argilla/clay ash

## Materiali e finiture / Materials and finishes

⚠ Verifica a listino la disponibilità delle finiture corrispondenti ad ogni collezione/prodotto  
Check the price list for the availability of finishes corresponding to each collection/product.  
Vérifiez dans la liste des prix la disponibilité des finitions correspondant à chaque collection/produit.

⚠ Überprüfen Sie in der Preisliste die Verfügbarkeit der Oberflächen, die den einzelnen Kollektionen/Produkten entsprechen.  
Verifique en la lista de precios la disponibilidad de los acabados correspondientes a cada colección/producto.

### HPL+metallo / HPL+metal

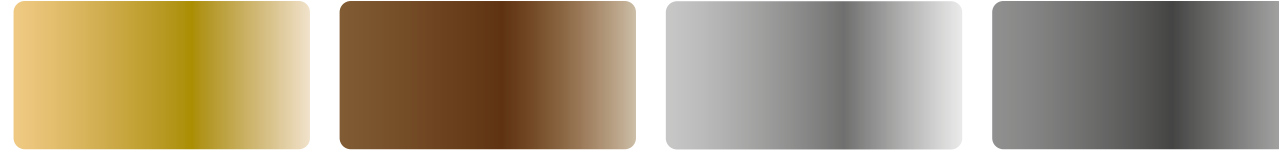

**C31**  
ottone/brass

**C32**  
ottone scuro/dark brass

**C35**  
inox/inox

**C36**  
inox scuro/dark inox

### HPL+Ecotouch



**N01**  
sabbia/sand

**N02**  
basalto/basalt

### HPL+cemento / HPL+concrete



**D01**  
bianco calce/lime white

**D02**  
grigio Portland/Portland grey

**D03**  
nero/black

### Ceramica Laminam® / Ceramic Laminam®



**S06**  
nero/black

**S07**  
porfido/porfido

**S08**  
cardodo/cardoso

**S09**  
Pompei/Pompei

**S10**  
Matera/Matera

**S11**  
tortora/dove grey

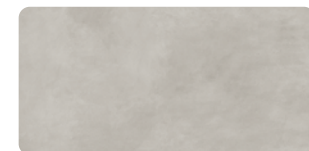

**S12**  
grigio/grey

new!

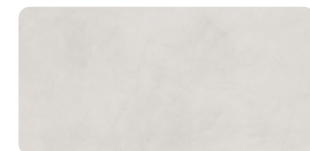

**S13**  
bianco/white

new!

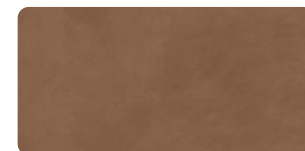

**S14**  
terracotta/earthenware

new!



**S15**  
muschio/moss

new!

## Materiali e finiture / Materials and finishes

⚠ Verifica a listino la disponibilità delle finiture corrispondenti ad ogni collezione/prodotto  
Check the price list for the availability of finishes corresponding to each collection/product.  
Vérifiez dans la liste des prix la disponibilité des finitions correspondant à chaque collection/produit.

⚠ Überprüfen Sie in der Preisliste die Verfügbarkeit der Oberflächen, die den einzelnen Kollektionen/Produkten entsprechen.  
Verifique en la lista de precios la disponibilidad de los acabados correspondientes a cada colección/producto.

### Pietre naturali / Natural stones

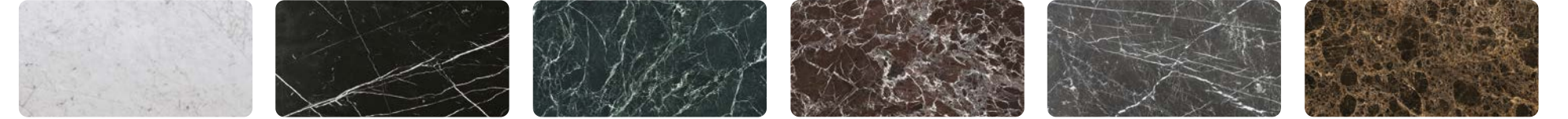

**Z01**  
bianco Carrara/white Carrara

new!

**Z02**  
nero Marquiña/black Marquiña

new!

**Z03**  
verde Alpi/green Alpi

new!

**Z04**  
rosso Lepanto/red Lepanto

new!

**Z05**  
grigio Carnico/grey Carnico

new!

**Z06**  
emperor dark/dark emperor

new!



**Z07**  
grafite/graphite

new!

**Z08**  
travertino sardo/travertino sardo

new!

**Z09**  
emperor light/light emperor

new!

### Argilla vetrificata / Vitrified clay



**U01**  
seta/silk

new!

**U02**  
mattone/brick

new!

**U03**  
muschio/moss

new!

### Cementi / Concretes (T13 base)

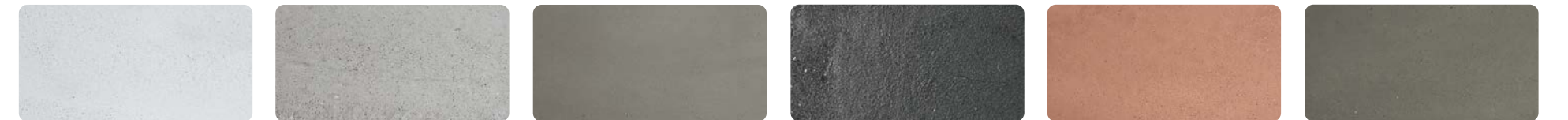

**K01**  
bianco/white (C12)

new!

**K02**  
seta/silk (C21)

new!

**K03**  
ghisa/cast-iron (C30)

new!

**K04**  
nero/black (C08)

new!

**K05**  
mattone/brick (C40)

new!

**K06**  
muschio/moss (C41)

new!



**K07**  
rame/copper (C37)

new!

BALANCE  
config. 01

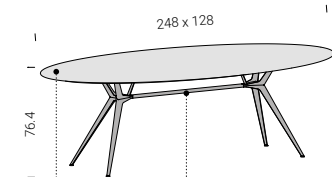

Z06  
emperador dark

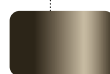

C29  
bronze



ECH10





BALANCE  
config. 02

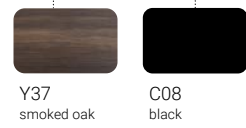
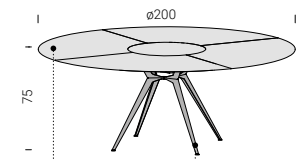

CONTRAPPESO

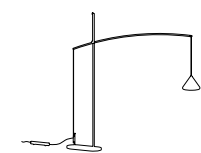

BALANCE + BALANCE bench  
config. 03 ☀️☁️

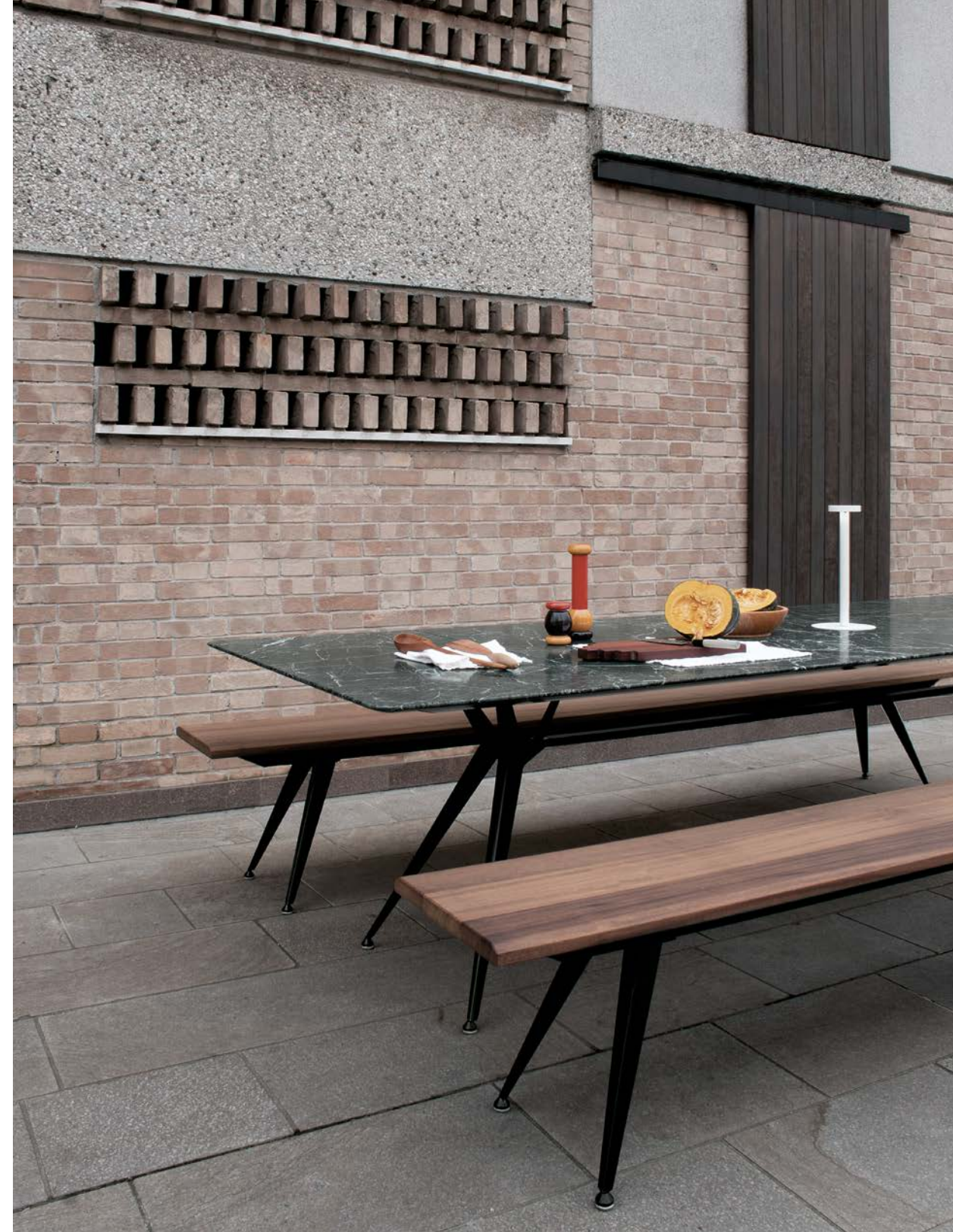

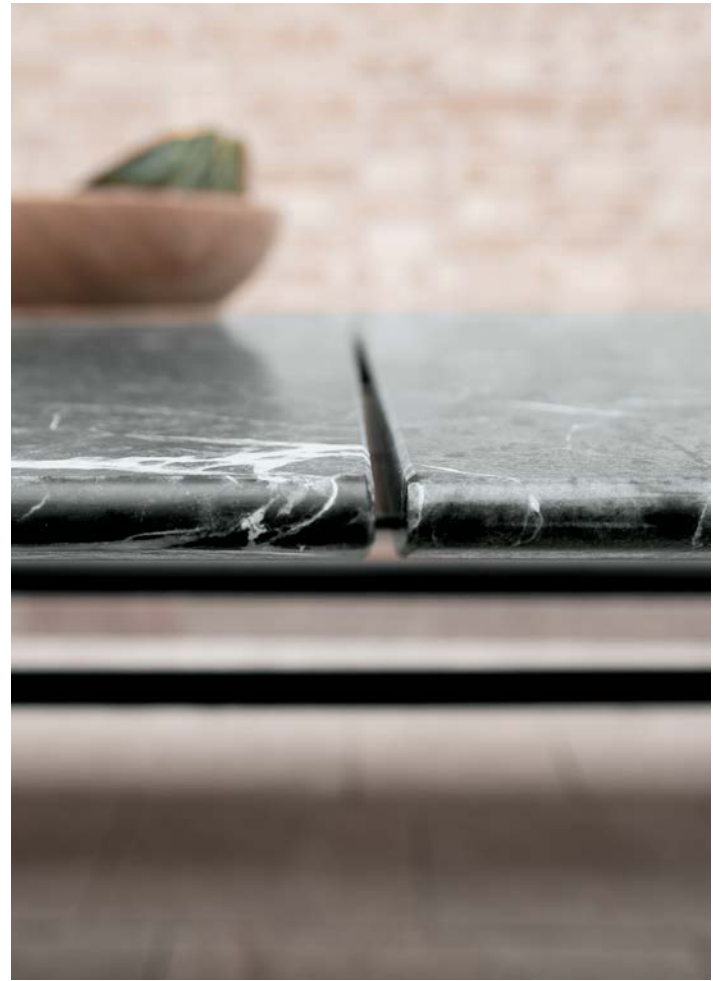
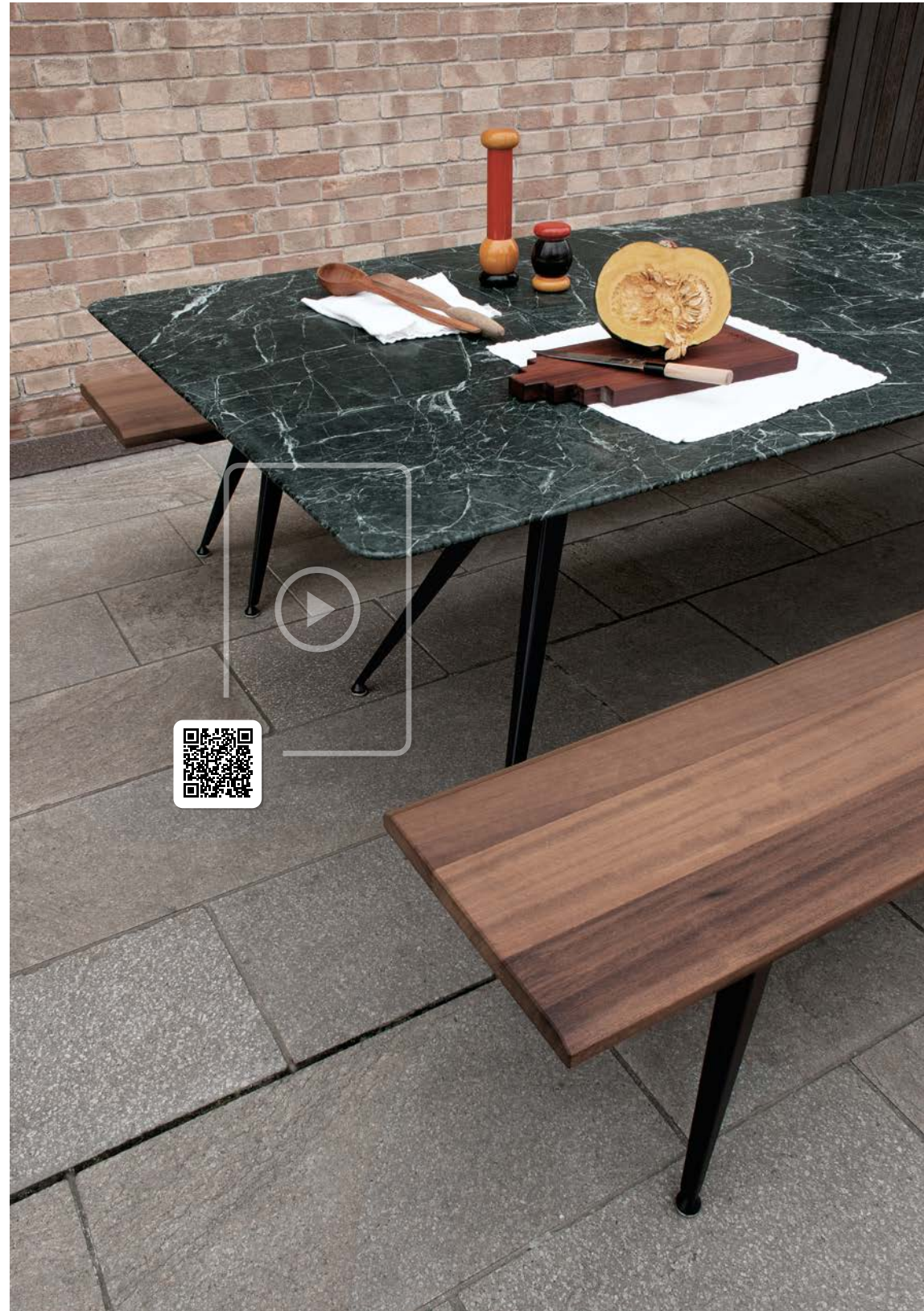



T8 bench  
config. 03

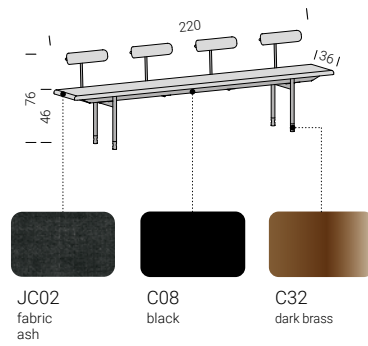

ECH3



T8

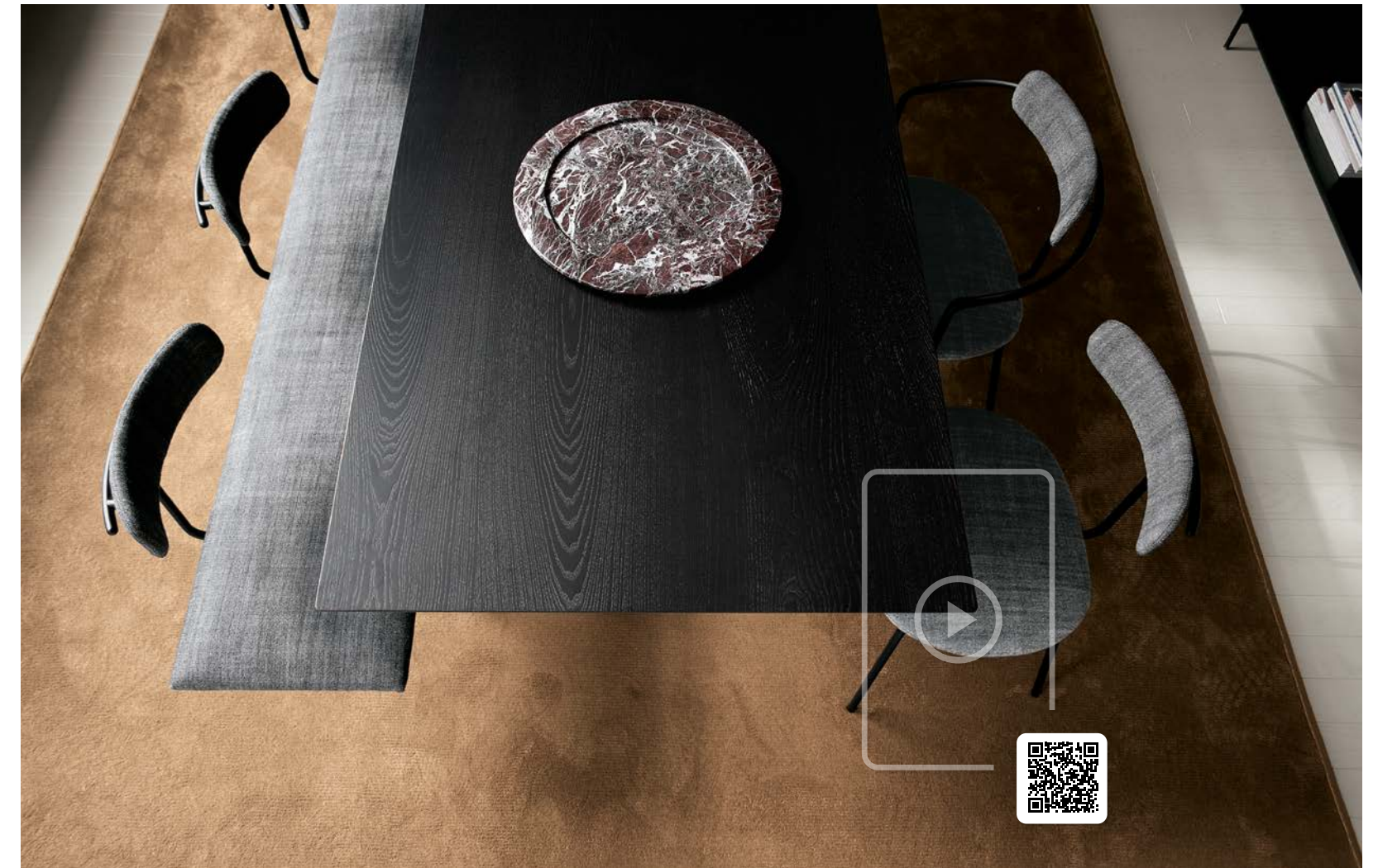



T8 + T8 bench  
config. 08 

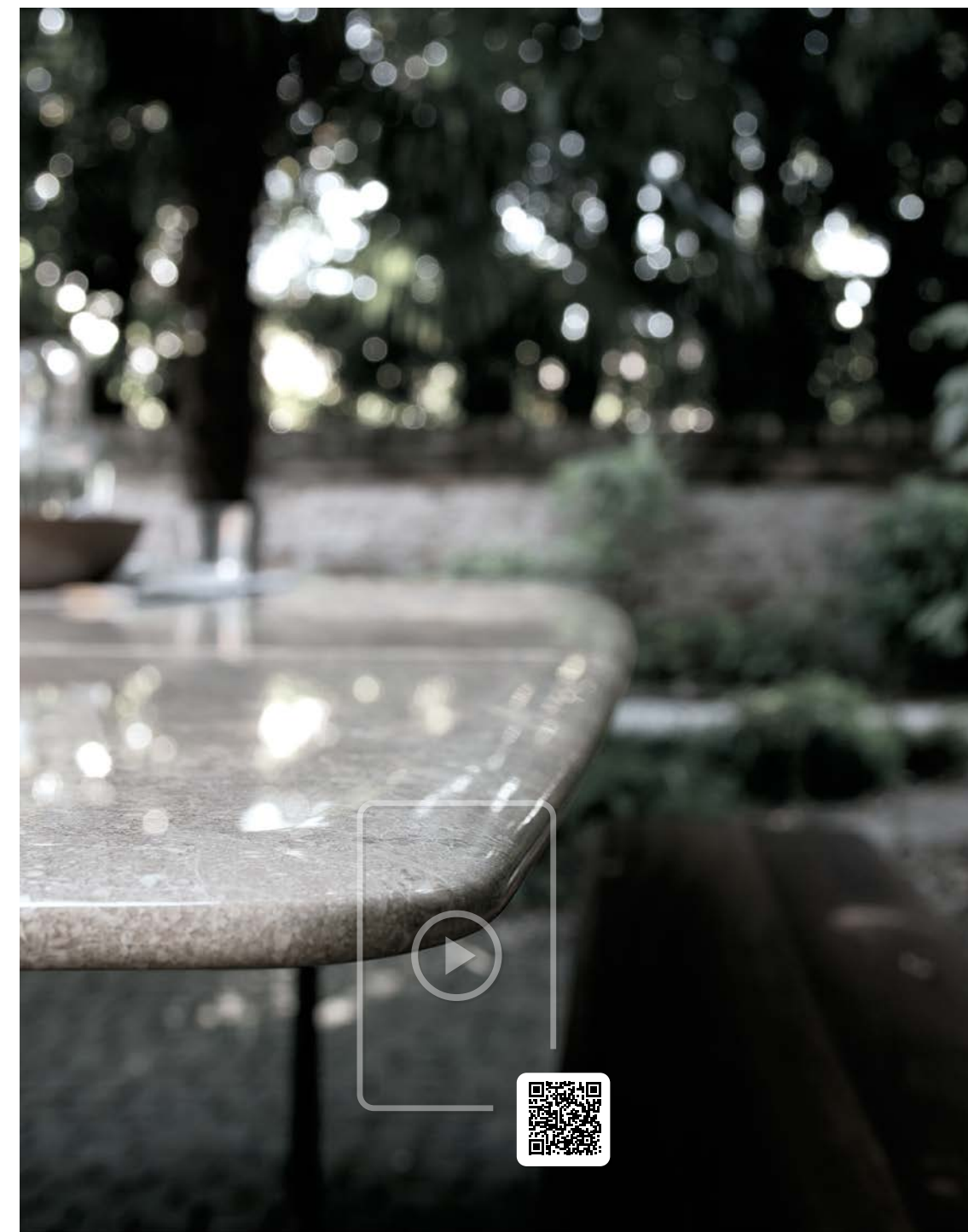
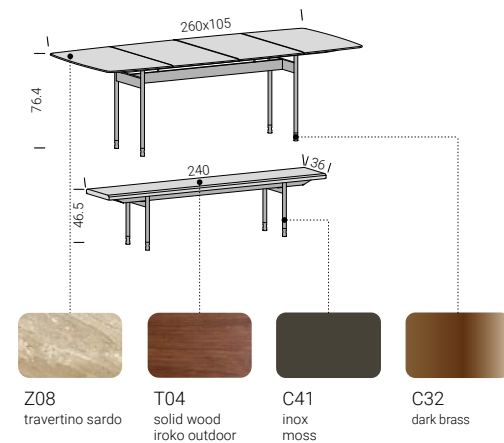





T8 + T8 bench  
config. 09 ☀️

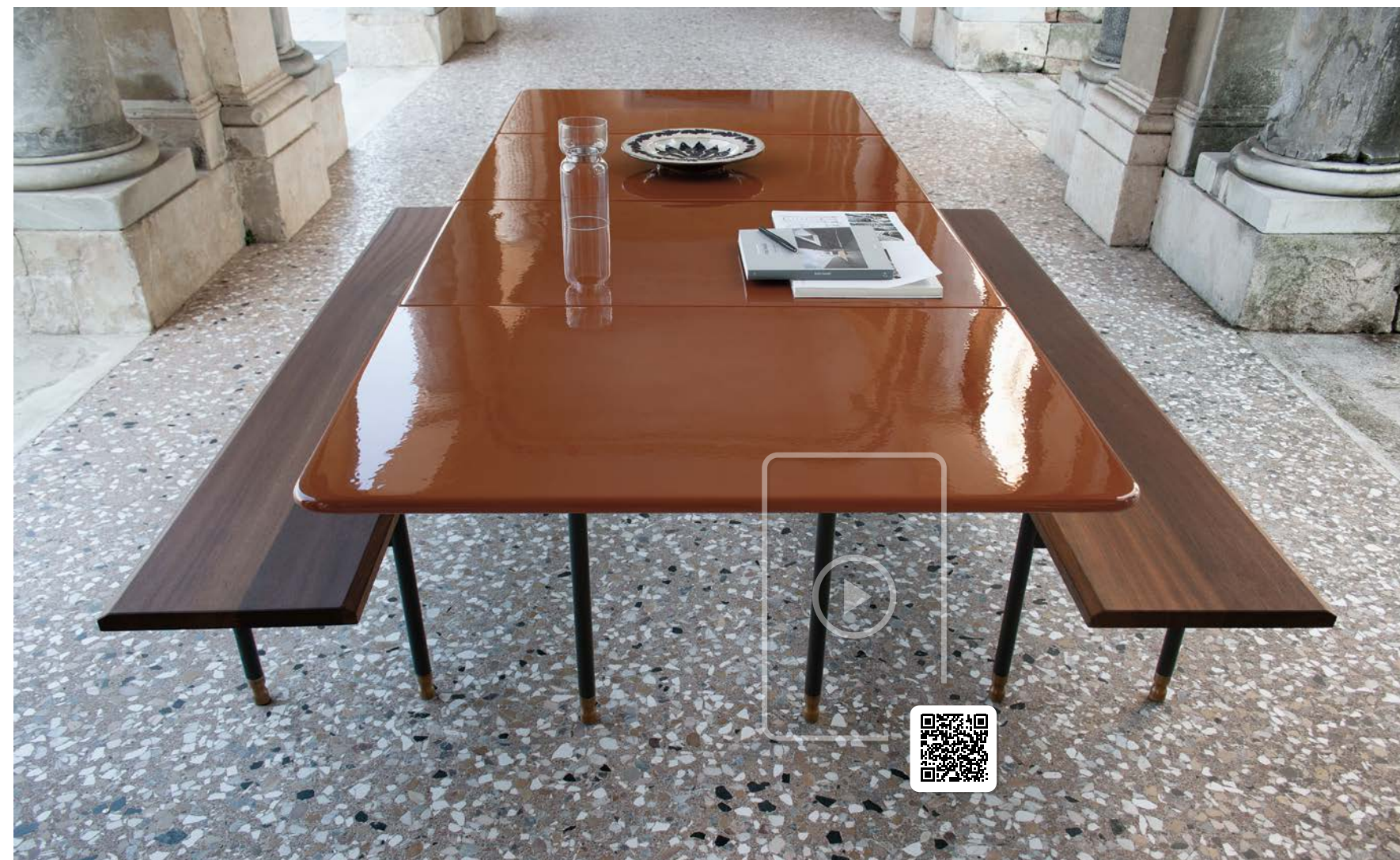
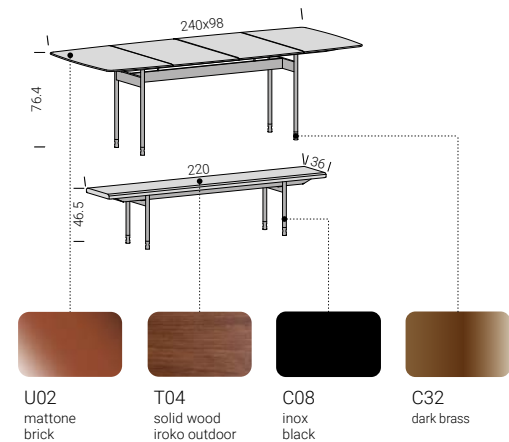



T9 + T9 bench  
config. 05 

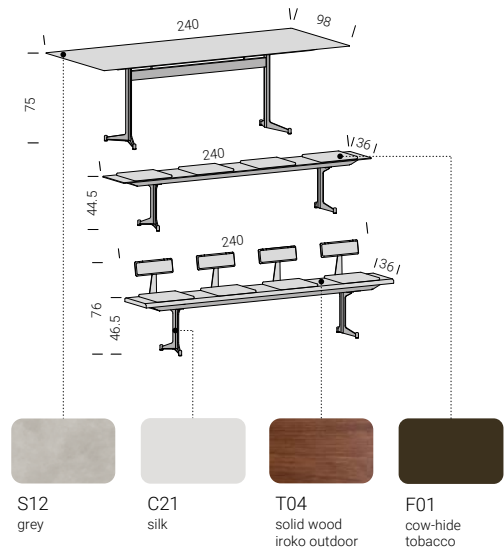



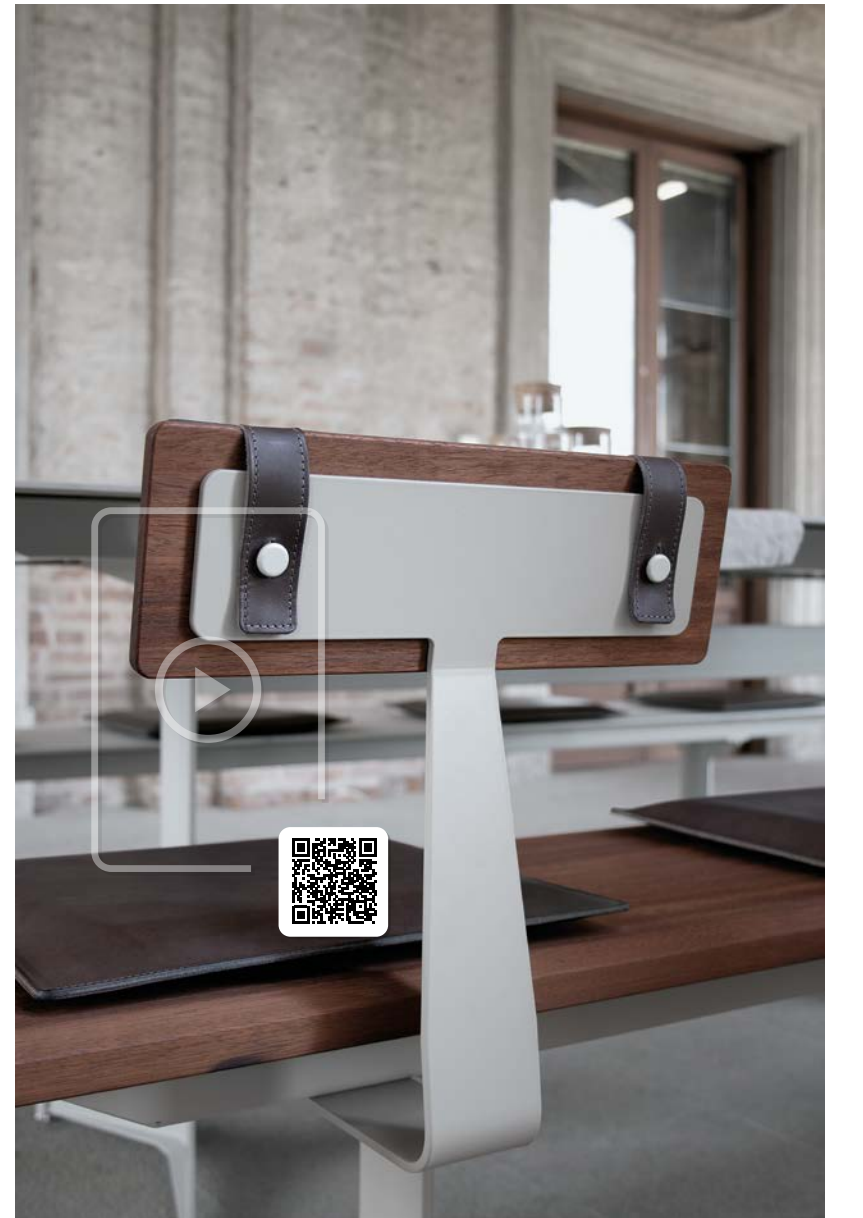

SINTESI + SINTESI bench  
config. 06 ☀️ ☁️

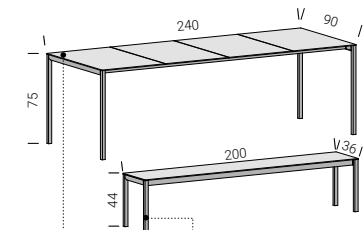

S14  
earthenware

C26  
corten

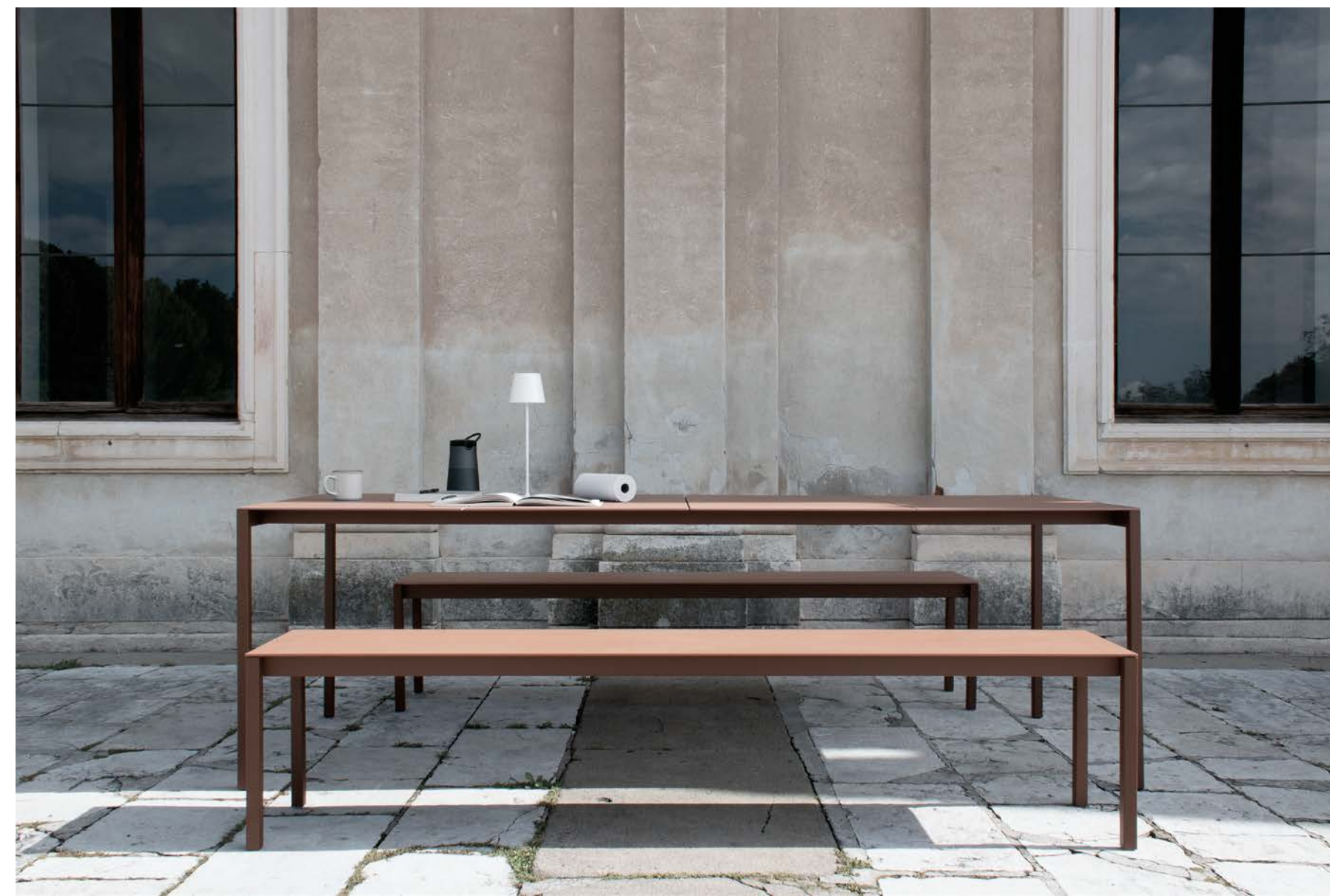
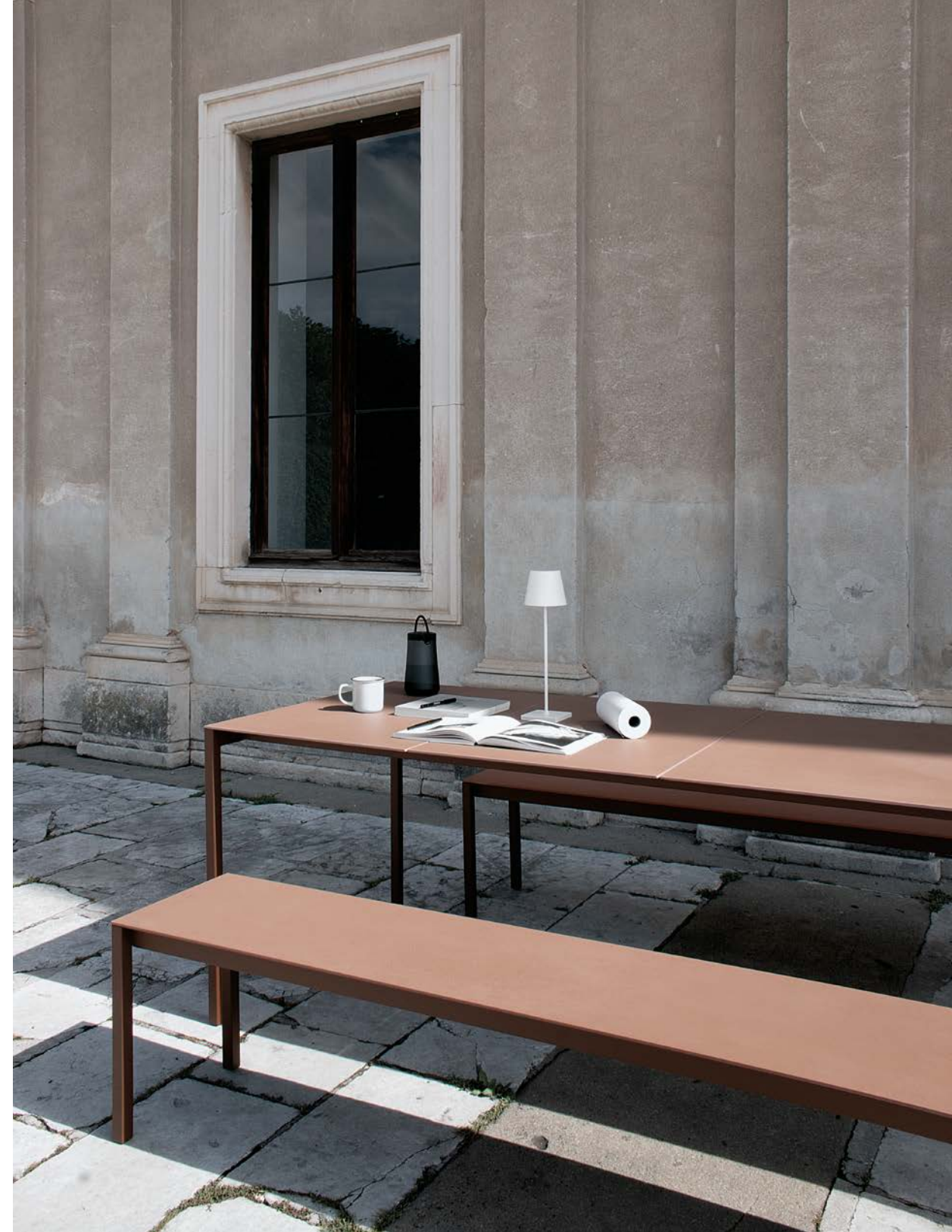



**art direction**  
extendo design dept.

**photo post-production**  
extendo design dept.  
marigraf.it

**graphic layout**  
marigraf.it



via Del Lavoro 2  
35010 Trebaseleghe PD - Italy

tel. +39 049 938 7633  
info@extendoweb.com  
www.extendoweb.com



